

**Standard brass fittings**



**LAKESHORE**  
FITTINGS

# Contents

|                    |                |  |  |
|--------------------|----------------|--|--|
|                    |                | <b>2&amp;3</b>                                   | About Lakeshore Fittings   |
| <b>Hose barb</b>   | <b>L102</b>    | <b>4</b>   | Hose barb to male pipe   |
|                    | <b>L103</b>    | <b>5</b>   | Hose barb to male pipe, swivel   |
|                    | <b>L105</b>    | <b>5</b>   | Hose barb to female pipe, swivel   |
|                    | <b>L104</b>    | <b>6</b>   | Hose barb to female pipe, swivel   |
|                    | <b>L100</b>    | <b>6</b>   | Hose barb to female hose, swivel, one-piece assembly                     |
|                    | <b>L124</b>    | <b>7</b>   | Hose barb to female swivel, ball seat, one-piece assembly                |
|                    | <b>L111</b>    | <b>7</b>   | Beaded hose barb to male pipe  |
|                    | <b>L143</b>    | <b>8</b>   | Hose barb to female swivel, dual angle, 37°/45° seat, one-piece assembly |
|                    | <b>L144</b>    | <b>8</b>   | Hose barb to female swivel, SAE, 45° seat, one-piece assembly            |
|                    | <b>L145</b>    | <b>9</b>   | Hose barb to female swivel, JIC, 37° seat, one-piece assembly            |
|                    | <b>L178</b>    | <b>9</b>   | Garden hose, barbed mender/splicer                                       |
|                    | <b>L296</b>    | <b>10</b>  | Push-on, barbed mender/splicer   |
|                    | <b>L284</b>    | <b>10</b>  | Push-on, barb to female swivel, SAE, 45° seat                            |
|                    | <b>Push-on</b> | <b>L287</b>                                      | <b>11</b>  |
| <b>L288</b>        |                | <b>11</b>  | Push-on, barb to female swivel, JIC, 37° seat                            |
| <b>L272</b>        |                | <b>12</b>  | Push-on, barb to male pipe   |
| <b>L274</b>        |                | <b>13</b>  | Push-on, barb to female pipe   |
| <b>L285</b>        |                | <b>14</b>  | Push-on, barb to male swivel   |
| <b>L286</b>        |                | <b>14</b>  | Push-on, barb to female swivel   |
| <b>Welding</b>     |                | <b>L152</b>                                      | <b>15</b>  |
|                    | <b>L154</b>    | <b>15</b>  | Welding hose, coupling, left hand, acetylene                             |
| <b>Pipe</b>        | <b>L163</b>    | <b>16</b>  | Hexagon pipe plug  |
|                    | <b>L313</b>    | <b>16</b>  | Hexagon pipe cap   |
|                    | <b>L370</b>    | <b>17</b>  | Hexagon nipple   |
|                    | <b>L371</b>    | <b>17</b>  | Hexagon coupling   |
|                    | <b>L373</b>    | <b>18</b>  | Hexagon reducing bushing   |
|                    | <b>L377</b>    | <b>18</b>  | Hexagon reducing bushing   |
| <b>Garden hose</b> | <b>OCTA</b>    | <b>19</b>  | Garden hose, octagon nut   |
|                    | <b>L513</b>    | <b>19</b>  | Garden hose, end cap   |
|                    | <b>L198</b>    | <b>20</b>  | Garden hose, male, short barb  |
|                    | <b>L199</b>    | <b>20</b>  | Garden hose, female swivel, short barb                                   |
|                    | <b>L190</b>    | <b>21</b>  | Garden hose, male  |
|                    | <b>L191</b>    | <b>21</b>  | Garden hose, female swivel   |
|                    | <b>L195</b>    | <b>22</b>  | Garden hose, female swivel, long barb                                    |
|                    | <b>L196</b>    | <b>22</b>  | Garden hose, female swivel, short barb                                   |
|                    | <b>AN</b>      | <b>23</b>  | Garden hose, spray nozzle, twist-type                                    |
|                    | <b>SN</b>      | <b>23</b>  | Garden hose, spray nozzle, sweeper                                       |
|                    | <b>HW</b>      | <b>23</b>  | Garden hose, washer  |
|                    | <b>QC</b>      | <b>24</b>  | Garden hose, quick connect coupler                                       |
| <b>WS</b>          | <b>24</b>      | Garden hose, quick-connect coupler with shut-off |  |
| <b>Adapter</b>     | <b>MF</b>      | <b>25&amp;26</b>                                 | Adapter male to female fittings  |
|                    | <b>MM</b>      | <b>26</b>  | Adapter garden hose to male pipe or hose                                 |
|                    | <b>FF</b>      | <b>27</b>  | Adapter female garden hose to female pipe or hose                        |
|                    | <b>FS</b>      | <b>27&amp;28</b>                                 | Adapter female garden hose to female garden hose or pipe, swivel         |
|                    | <b>LMFS</b>    | <b>28</b>  | Adapter female hose to male pipe, swivel and male pipe hose spud         |
| <b>Octight™</b>    | <b>L898</b>    | <b>30</b>  | Garden hose, male, short barb  |
|                    | <b>L899</b>    | <b>30</b>  | Garden hose, female swivel, short barb                                   |
|                    | <b>L802</b>    | <b>31</b>  | Hose barb to male pipe   |
|                    |                | <b>32</b>  | Custom fittings  |
|                    |                | <b>33</b>  | Lead-free fittings   |
|                    |                | <b>34</b>  | Definitions, terms, and details  |
|                    | <b>35</b>      | Credit application                               |  |
|                    | <b>36</b>      | Notes  |  |

# Accomovative™

## Fitting service

Lakeshore Fittings is your choice for **Accomovative™** service and precision machined brass fittings and assemblies. We go the extra mile to accommodate customer requests, with our primary goal being your complete satisfaction. Lakeshore Fittings is the industry leader, developing innovative new products including lead-free brass solutions. We are the preferred provider for customers

in the automotive, petroleum distribution, hydraulic, plumbing, gas distribution, and lawn & garden industries.

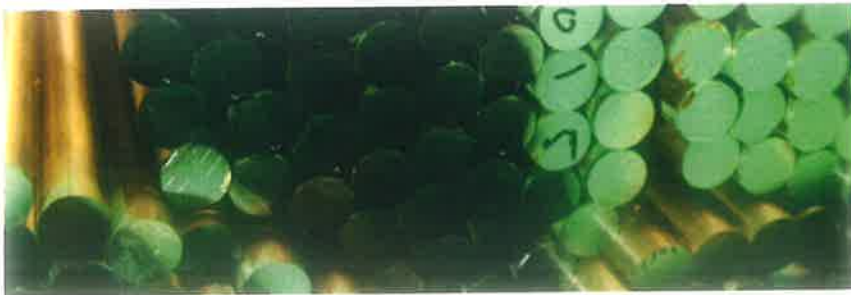

**$Cu_3Zn_2 - Pb$**   
LAKESHORE LEAD-FREE FITTINGS™

## and innovation

Our customers expect outstanding service, quality, delivery, and competitive prices, and we exceed those expectations with an **Accomovative™** approach that is unmatched in the industry. Our track record of innovation includes five patented products, **expertise** in the machining of lead-free brass to meet changing state and federal regulations, and leading-edge **Octight™** designs.



**Octight™**

Our facility features the latest technologies, including rotary transfer machines, multiple-spindle bar machines, CNC machines and a variety of automatic secondary and assembly equipment to machine tens of thousands of pounds of brass each day.



## Our Accomōvative™ capabilities

- We are a high-speed machining facility that specializes in the design and manufacture of brass fittings.
- We produce fittings from brass rod ranging in size from 3/8" to 4".
- We hold patents on five innovative lawn & garden products.
- We produce custom fittings and assemblies to customer specifications, often assisting in part design to reduce cost and/or improve functionality.
- We are certified to ISO 9001:2008.
- We employ LEAN concepts and practices in all that we do.
- We machine only non-ferrous metals, more than 50,000 lbs every day.
- We produce parts in quantities from 1 to more than 10,000,000.
- We produce a line of standard brass fittings and adapters.
- We are dedicated to leading the machined brass fittings industry with new, innovative products.
- We are focused on complete customer satisfaction as our primary goal.



## LAKESHORE FITTINGS

Lakeshore Automatic Products, Inc. was founded in 1980, built its own facility in 1989, and has been providing quality products and exceptional service ever since. **In 2008, we changed our name to Lakeshore Fittings, Inc. to better reflect our product offering.**

Today, our 60,000 sq. ft. facility in Grand Haven, Michigan features state-of-the-art machining equipment particularly suited for the high-speed production of machined brass fittings.

Our mission is to secure the highest level of customer satisfaction and loyalty. The employees at Lakeshore Fittings will work to continuously improve the quality of our products and services. Our customer's complete satisfaction is our primary goal.

## Hose barb to male pipe

### L102 series

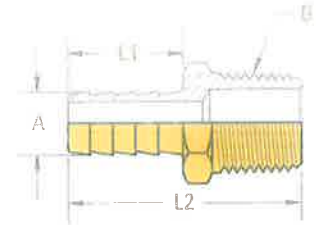

| Part number      | Hose ID<br>A | NPTF thread<br>B | Barb length<br>L1 | Overall length<br>L2 | Hex size | Flow<br>diameter |
|------------------|--------------|------------------|-------------------|----------------------|----------|------------------|
| <b>L102-0302</b> | 3/16"        | 1/8"-27          | .69               | 1.25                 | 1/2"     | .12              |
| <b>L102-0304</b> | 3/16"        | 1/4"-18          | .69               | 1.48                 | 9/16"    | .12              |
| <b>L102-0402</b> | 1/4"         | 1/8"-27          | .97               | 1.53                 | 1/2"     | .17              |
| <b>L102-0404</b> | 1/4"         | 1/4"-18          | .97               | 1.76                 | 9/16"    | .17              |
| <b>L102-0406</b> | 1/4"         | 3/8"-18          | .97               | 1.76                 | 11/16"   | .17              |
| <b>L102-0502</b> | 5/16"        | 1/8"-27          | .97               | 1.53                 | 1/2"     | .22              |
| <b>L102-0504</b> | 5/16"        | 1/4"-18          | .97               | 1.76                 | 9/16"    | .22              |
| <b>L102-0506</b> | 5/16"        | 3/8"-18          | .97               | 1.76                 | 11/16"   | .22              |
| <b>L102-0602</b> | 3/8"         | 1/8"-27          | .97               | 1.53                 | 1/2"     | .22              |
| <b>L102-0604</b> | 3/8"         | 1/4"-18          | .97               | 1.76                 | 9/16"    | .26              |
| <b>L102-0606</b> | 3/8"         | 3/8"-18          | .97               | 1.76                 | 11/16"   | .26              |
| <b>L102-0608</b> | 3/8"         | 1/2"-14          | .97               | 1.97                 | 7/8"     | .26              |
| <b>L102-0804</b> | 1/2"         | 1/4"-18          | .97               | 1.76                 | 9/16"    | .37              |
| <b>L102-0806</b> | 1/2"         | 3/8"-18          | .97               | 1.76                 | 11/16"   | .37              |
| <b>L102-0808</b> | 1/2"         | 1/2"-14          | .97               | 1.97                 | 7/8"     | .37              |
| <b>L102-0812</b> | 1/2"         | 3/4"-14          | .97               | 1.97                 | 1 1/16"  | .41              |
| <b>L102-1006</b> | 5/8"         | 3/8"-18          | .97               | 1.76                 | 11/16"   | .47              |
| <b>L102-1008</b> | 5/8"         | 1/2"-14          | .97               | 1.97                 | 7/8"     | .47              |
| <b>L102-1012</b> | 5/8"         | 3/4"-14          | .97               | 1.97                 | 1 1/16"  | .50              |
| <b>L102-1208</b> | 3/4"         | 1/2"-14          | .97               | 1.97                 | 7/8"     | .56              |
| <b>L102-1212</b> | 3/4"         | 3/4"-14          | .97               | 1.97                 | 1 1/16"  | .62              |
| <b>L102-1216</b> | 3/4"         | 1"-11 1/2        | 1.19              | 2.53                 | 1 3/8"   | .62              |
| <b>L102-1612</b> | 1"           | 3/4"-14          | 1.19              | 2.19                 | 1 1/16"  | .75              |
| <b>L102-1616</b> | 1"           | 1"-11 1/2        | 1.19              | 2.53                 | 1 3/8"   | .85              |
| <b>L102-2012</b> | 1 1/4"       | 3/4"-14          | 1.19              | 2.28                 | 1 3/8"   | .75              |
| <b>L102-2016</b> | 1 1/4"       | 1"-11 1/2        | 1.19              | 2.53                 | 1 3/8"   | 1.00             |

## Hose barb to male pipe, swivel

### L103 series

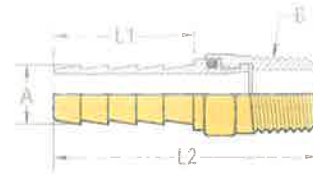

| Part number      | Hose ID<br>A | NPTF thread<br>B | Barb length<br>L1 | Overall length<br>L2 | Hex size | Flow<br>diameter |
|------------------|--------------|------------------|-------------------|----------------------|----------|------------------|
| <b>L103-0302</b> | 3/16"        | 1/8"-27          | .69               | 1.48                 | 1/2"     | .12              |
| <b>L103-0402</b> | 1/4"         | 1/8"-27          | .97               | 1.76                 | 1/2"     | .17              |
| <b>L103-0404</b> | 1/4"         | 1/4"-18          | .97               | 1.80                 | 9/16"    | .17              |
| <b>L103-0504</b> | 5/16"        | 1/4"-18          | .97               | 1.80                 | 9/16"    | .22              |
| <b>L103-0604</b> | 3/8"         | 1/4"-18          | .97               | 1.80                 | 9/16"    | .26              |
| <b>L103-0606</b> | 3/8"         | 3/8"-18          | .97               | 1.80                 | 3/4"     | .26              |
| <b>L103-0608</b> | 3/8"         | 1/2"-14          | .97               | 2.00                 | 7/8"     | .26              |
| <b>L103-0806</b> | 1/2"         | 3/8"-18          | .97               | 1.80                 | 3/4"     | .37              |
| <b>L103-0808</b> | 1/2"         | 1/2"-14          | .97               | 2.00                 | 7/8"     | .37              |
| <b>L103-1212</b> | 3/4"         | 3/4"-14          | .97               | 2.15                 | 1 1/8"   | .56              |

## Hose barb to female pipe, swivel

### L105 series

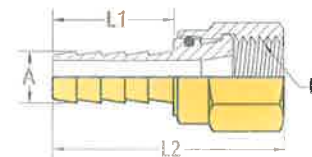

| Part number      | Hose ID<br>A | NPTF thread<br>B | Barb length<br>L1 | Overall length<br>L2 | Hex size | Flow<br>diameter |
|------------------|--------------|------------------|-------------------|----------------------|----------|------------------|
| <b>L105-0302</b> | 3/16"        | 1/8"-27          | .69               | 1.45                 | 1/2"     | .12              |
| <b>L105-0402</b> | 1/4"         | 1/8"-27          | .97               | 1.73                 | 1/2"     | .17              |
| <b>L105-0404</b> | 1/4"         | 1/4"-18          | .97               | 1.80                 | 5/8"     | .17              |
| <b>L105-0504</b> | 5/16"        | 1/4"-18          | .97               | 1.80                 | 5/8"     | .22              |
| <b>L105-0604</b> | 3/8"         | 1/4"-18          | .97               | 1.80                 | 5/8"     | .26              |
| <b>L105-0606</b> | 3/8"         | 3/8"-18          | .97               | 1.82                 | 3/4"     | .26              |
| <b>L105-0608</b> | 3/8"         | 1/2"-14          | .97               | 1.86                 | 15/16"   | .26              |
| <b>L105-0806</b> | 1/2"         | 3/8"-18          | .97               | 1.82                 | 3/4"     | .37              |
| <b>L105-0808</b> | 1/2"         | 1/2"-14          | .97               | 1.86                 | 15/16"   | .37              |

## Hose barb to female pipe

### L104 series

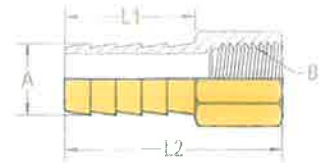

| Part number | Hose ID<br>A | NPTF thread<br>B | Barb length<br>L1 | Overall length<br>L2 | Hex size | Flow<br>diameter |
|-------------|--------------|------------------|-------------------|----------------------|----------|------------------|
| L104-0402   | 1/4"         | 1/8"-27          | .97               | 1.45                 | 1/2"     | .17              |
| L104-0404   | 1/4"         | 1/4"-18          | .97               | 1.61                 | 5/8"     | .17              |
| L104-0406   | 1/4"         | 3/8"-18          | .97               | 1.63                 | 3/4"     | .17              |
| L104-0502   | 5/16"        | 1/8"-27          | .97               | 1.45                 | 1/2"     | .22              |
| L104-0504   | 5/16"        | 1/4"-18          | .97               | 1.61                 | 5/8"     | .22              |
| L104-0506   | 5/16"        | 3/8"-18          | .97               | 1.63                 | 3/4"     | .22              |
| L104-0602   | 3/8"         | 1/8"-27          | .97               | 1.45                 | 1/2"     | .26              |
| L104-0604   | 3/8"         | 1/4"-18          | .97               | 1.61                 | 5/8"     | .26              |
| L104-0606   | 3/8"         | 3/8"-18          | .97               | 1.63                 | 3/4"     | .26              |
| L104-0608   | 3/8"         | 1/2"-14          | .97               | 1.77                 | 15/16"   | .26              |
| L104-0804   | 1/2"         | 1/4"-18          | .97               | 1.61                 | 5/8"     | .37              |
| L104-0806   | 1/2"         | 3/8"-18          | .97               | 1.63                 | 3/4"     | .37              |
| L104-0808   | 1/2"         | 1/2"-14          | .97               | 1.77                 | 15/16"   | .37              |
| L104-1006   | 5/8"         | 3/8"-18          | .97               | 1.63                 | 3/4"     | .50              |
| L104-1008   | 5/8"         | 1/2"-14          | .97               | 1.77                 | 15/16"   | .50              |
| L104-1208   | 3/4"         | 1/2"-14          | .97               | 1.77                 | 15/16"   | .62              |
| L104-1212   | 3/4"         | 3/4"-14          | .97               | 1.77                 | 1 1/8"   | .62              |
| L104-1612   | 1"           | 3/4"-14          | .97               | 1.77                 | 1 1/8"   | .85              |

## Hose barb to female hose, swivel, one-piece assembly

### L100 series

Garden hose washer included

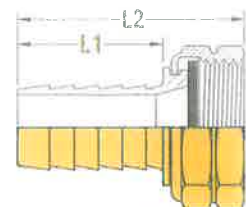

| Part number | Hose ID | NPSM thread | Barb length<br>L1 | Overall length<br>L2 | Hex size | Flow<br>diameter |
|-------------|---------|-------------|-------------------|----------------------|----------|------------------|
| L100-0612   | 3/8"    | 3/4"-14     | 1.12              | 1.71                 | 1 5/32"  | .28              |
| L100-0812   | 1/2"    | 3/4"-14     | 1.12              | 1.71                 | 1 5/32"  | .41              |
| L100-1012   | 5/8"    | 3/4"-14     | 1.12              | 1.71                 | 1 5/32"  | .50              |
| L100-1212   | 3/4"    | 3/4"-14     | 1.12              | 1.71                 | 1 5/32"  | .62              |

## Hose barb to female swivel, ball seat, one-piece assembly

### L124 series

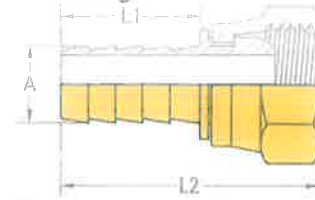

| Part number | Hose ID<br>A | NPSM thread | Barb length<br>L1 | Overall length<br>L2 | Hex size | Flow<br>diameter |
|-------------|--------------|-------------|-------------------|----------------------|----------|------------------|
| L124-0404   | 1/4"         | 1/4"-18     | .97               | 1.56                 | 5/8"     | .18              |
| L124-0504   | 5/16"        | 1/4"-18     | .97               | 1.56                 | 5/8"     | .22              |
| L124-0604   | 3/8"         | 1/4"-18     | .97               | 1.56                 | 5/8"     | .26              |
| L124-0606   | 3/8"         | 3/8"-18     | .97               | 1.62                 | 9/16"    | .28              |
| L124-0806   | 1/2"         | 3/8"-18     | .97               | 1.62                 | 3/4"     | .37              |
| L124-0808   | 1/2"         | 1/2"-14     | .97               | 1.73                 | 15/16"   | .40              |
| L124-1212   | 3/4"         | 3/4"-14     | .97               | 1.73                 | 1 1/8"   | .65              |

## Beaded hose barb to male pipe

### L111 series

Reference SAE standard 430160

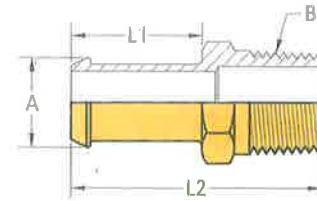

| Part number | Hose ID<br>A | NPTF thread<br>B | Barb length<br>L1 | Overall length<br>L2 | Hex size | Flow<br>diameter |
|-------------|--------------|------------------|-------------------|----------------------|----------|------------------|
| L111-0402   | 1/4"         | 1/8"-27          | .62               | 1.18                 | 1/2"     | .17              |
| L111-0404   | 1/4"         | 1/4"-18          | .62               | 1.41                 | 9/16"    | .17              |
| L111-0502   | 5/16"        | 1/8"-27          | .62               | 1.18                 | 1/2"     | .23              |
| L111-0504   | 5/16"        | 1/4"-18          | .62               | 1.41                 | 9/16"    | .23              |
| L111-0602   | 3/8"         | 1/8"-27          | .87               | 1.43                 | 1/2"     | .23              |
| L111-0604   | 3/8"         | 1/4"-18          | .87               | 1.67                 | 9/16"    | .28              |
| L111-0606   | 3/8"         | 3/8"-18          | .87               | 1.67                 | 11/16"   | .28              |
| L111-0806   | 1/2"         | 3/8"-18          | .87               | 1.67                 | 11/16"   | .41              |
| L111-0808   | 1/2"         | 1/2"-14          | .87               | 1.88                 | 7/8"     | .41              |
| L111-1008   | 5/8"         | 1/2"-14          | .87               | 1.88                 | 7/8"     | .50              |
| L111-1012   | 5/8"         | 3/4"-14          | .87               | 1.88                 | 1 1/16"  | .50              |
| L111-1208   | 3/4"         | 1/2"-14          | .87               | 1.88                 | 7/8"     | .57              |
| L111-1212   | 3/4"         | 3/4"-14          | .87               | 1.88                 | 1 1/16"  | .66              |



## Hose barb to female swivel, dual angle, 37°/45° seat, one-piece assembly L143 series

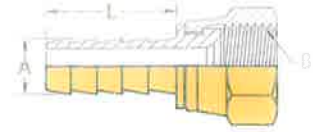

| Part number      | Hose ID<br>A | Tube size | Thread size<br>B | Barb length<br>L | Hex size | Flow<br>diameter |
|------------------|--------------|-----------|------------------|------------------|----------|------------------|
| <b>L143-0404</b> | 1/4"         | 4         | 7/16"-20         | .97              | 9/16"    | .17              |
| <b>L143-0405</b> | 1/4"         | 5         | 1/2"-20          | .97              | 5/8"     | .17              |
| <b>L143-0505</b> | 5/16"        | 5         | 1/2"-20          | .97              | 5/8"     | .22              |
| <b>L143-0608</b> | 3/8"         | 8         | 3/4"-16          | .97              | 7/8"     | .28              |
| <b>L143-0808</b> | 1/2"         | 8         | 3/4"-16          | .97              | 7/8"     | .40              |
| <b>L143-0810</b> | 1/2"         | 10        | 7/8"-14          | .97              | 1"       | .40              |
| <b>L143-1010</b> | 5/8"         | 10        | 7/8"-14          | .97              | 1"       | .50              |
| <b>L143-1210</b> | 3/4"         | 10        | 7/8"-14          | .97              | 1"       | .56              |

## Hose barb to female swivel, SAE, 45° seat, one-piece assembly L144 series

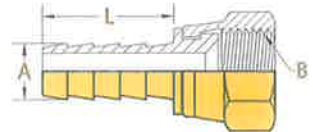

| Part number       | Hose ID<br>A | Tube size | Thread size<br>B | Barb length<br>L | Hex size | Flow<br>diameter |
|-------------------|--------------|-----------|------------------|------------------|----------|------------------|
| <b>L144-0406</b>  | 1/4"         | 6         | 5/8"-18          | .97              | 3/4"     | .17              |
| <b>L144-0506</b>  | 5/16"        | 6         | 5/8"-18          | .97              | 3/4"     | .22              |
| <b>L144-0606</b>  | 3/8"         | 6         | 5/8"-18          | .97              | 3/4"     | .28              |
| <b>L144-1212*</b> | 3/4"         | 12        | 1 1/16"-14       | .97              | 1 1/4"   | .62              |

\* Notch in corners of hex for SAE identification

## Hose barb to female swivel, JIC, 37° seat, one-piece assembly

### L145 series

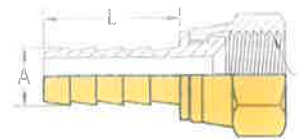

| Part number      | Hose ID<br>A | Tube size | Thread size<br>B | Barb length<br>L | Hex size | Flow<br>diameter |
|------------------|--------------|-----------|------------------|------------------|----------|------------------|
| <b>L145-0406</b> | 1/4"         | 6         | 9/16"-18         | .97              | 11/16"   | .17              |
| <b>L145-0506</b> | 5/16"        | 6         | 9/16"-18         | .97              | 11/16"   | .22              |
| <b>L145-0606</b> | 3/8"         | 6         | 9/16"-18         | .97              | 11/16"   | .28              |
| <b>L145-1212</b> | 3/4"         | 12        | 1 1/16"-12       | .97              | 1 1/4"   | .62              |

## Garden hose, barbed mender/splicer

### L178 series

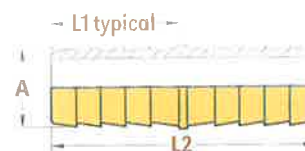

| Part number      | Hose ID<br>A | Barb length<br>L1 | Overall length<br>L2 | Flow<br>diameter |
|------------------|--------------|-------------------|----------------------|------------------|
| <b>L178-0404</b> | 1/4"         | .97               | 2.00                 | .17              |
| <b>L178-0505</b> | 5/16"        | .97               | 2.00                 | .22              |
| <b>L178-0606</b> | 3/8"         | .97               | 2.00                 | .40              |
| <b>L178-0808</b> | 1/2"         | .97               | 2.00                 | .40              |
| <b>L178-1010</b> | 5/8"         | .97               | 2.00                 | .50              |
| <b>L178-1212</b> | 3/4"         | .97               | 2.00                 | .62              |
| <b>L178-1616</b> | 1"           | .97               | 2.00                 | .87              |

## Push-on, barbed mender/splicer

### L296 series

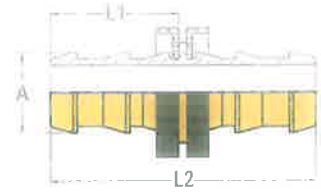

| Part number      | Hose ID<br>A | Barb length<br>L1 | Overall length<br>L2 | Flow<br>diameter |
|------------------|--------------|-------------------|----------------------|------------------|
| <b>L296-0404</b> | 1/4"         | .87               | 1.80                 | .17              |
| <b>L296-0505</b> | 5/16"        | .87               | 1.80                 | .23              |
| <b>L296-0606</b> | 3/8"         | .97               | 2.00                 | .28              |
| <b>L296-0808</b> | 1/2"         | .97               | 2.00                 | .40              |
| <b>L296-1010</b> | 5/8"         | 1.45              | 3.03                 | .53              |
| <b>L296-1212</b> | 3/4"         | 1.45              | 3.03                 | .65              |

## Push-on, barb to female swivel, SAE, 45° seat

### L284 series

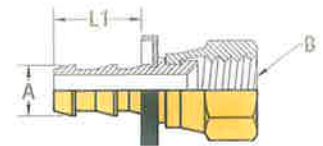

| Part number       | Hose ID<br>A | Tube size | Thread size<br>B | Barb length<br>L | Hex size | Flow<br>diameter |
|-------------------|--------------|-----------|------------------|------------------|----------|------------------|
| <b>L284-0406</b>  | 1/4"         | 6         | 5/8"-18          | .87              | 3/4"     | .17              |
| <b>L284-0506</b>  | 5/16"        | 6         | 5/8"-18          | .87              | 3/4"     | .23              |
| <b>L284-0606</b>  | 3/8"         | 6         | 5/8"-18          | .97              | 3/4"     | .27              |
| <b>L284-1212*</b> | 3/4"         | 12        | 1 1/16"-14       | 1.45             | 1 1/4"   | .66              |

\* Notch in corners of hex for SAE identification

## Push-on, barb to female swivel, dual angle, 37°/45° seat

### L287 series

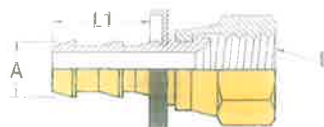

| Part number | Hose ID<br>A | Tube size | Thread size<br>B | Barb length<br>L | Hex size | Flow<br>diameter |
|-------------|--------------|-----------|------------------|------------------|----------|------------------|
| L287-0404   | 1/4"         | 4         | 7/16"-20         | .87              | 9/16"    | .17              |
| L287-0405   | 1/4"         | 5         | 1/2"-20          | .87              | 5/8"     | .17              |
| L287-0505   | 5/16"        | 5         | 1/2"-20          | .87              | 5/8"     | .23              |
| L287-0608   | 3/8"         | 8         | 3/4"-16          | .97              | 7/8"     | .28              |
| L287-0808   | 1/2"         | 8         | 3/4"-16          | .97              | 7/8"     | .41              |
| L287-0810   | 1/2"         | 10        | 7/8"-14          | .97              | 1"       | .41              |
| L287-1008   | 5/8"         | 8         | 3/4"-16          | 1.45             | 7/8"     | .41              |
| L287-1010   | 5/8"         | 10        | 7/8"-14          | 1.45             | 1"       | .53              |
| L287-1210   | 3/4"         | 10        | 7/8"-14          | 1.45             | 1"       | .56              |

## Push-on, barb to female swivel, JIC, 37° seat

### L288 series

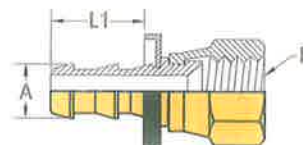

| Part number | Hose ID<br>A | Tube size | Thread size<br>B | Barb length<br>L | Hex size | Flow<br>diameter |
|-------------|--------------|-----------|------------------|------------------|----------|------------------|
| L288-0406   | 1/4"         | 6         | 9/16"-18         | .87              | 11/16"   | .17              |
| L288-0506   | 5/16"        | 6         | 9/16"-18         | .87              | 11/16"   | .23              |
| L288-0606   | 3/8"         | 6         | 9/16"-18         | .97              | 11/16"   | .28              |
| L288-1212   | 3/4"         | 12        | 1 1/16"-12       | 1.45             | 1 1/4"   | .66              |

## Push-on, barb to male pipe

### L272 series

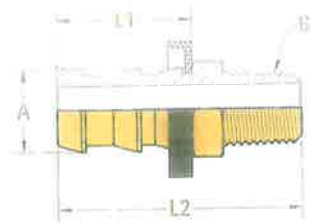

| Part number      | Hose ID<br>A | NPTF thread<br>B | Barb length<br>L1 | Overall length<br>L2 | Hex size | Flow<br>diameter |
|------------------|--------------|------------------|-------------------|----------------------|----------|------------------|
| <b>L272-0402</b> | 1/4"         | 1/8"-27          | .87               | 1.43                 | 1/2"     | .17              |
| <b>L272-0404</b> | 1/4"         | 1/4"-18          | .87               | 1.66                 | 9/16"    | .17              |
| <b>L272-0406</b> | 1/4"         | 3/8"-18          | .87               | 1.66                 | 11/16"   | .17              |
| <b>L272-0502</b> | 5/16"        | 1/8"-27          | .87               | 1.43                 | 1/2"     | .22              |
| <b>L272-0504</b> | 5/16"        | 1/4"-18          | .87               | 1.66                 | 9/16"    | .23              |
| <b>L272-0602</b> | 3/8"         | 1/8"-27          | .97               | 1.53                 | 1/2"     | .22              |
| <b>L272-0604</b> | 3/8"         | 1/4"-18          | .97               | 1.76                 | 9/16"    | .28              |
| <b>L272-0606</b> | 3/8"         | 3/8"-18          | .97               | 1.76                 | 11/16"   | .28              |
| <b>L272-0608</b> | 3/8"         | 1/2"-14          | .97               | 1.97                 | 7/8"     | .28              |
| <b>L272-0804</b> | 1/2"         | 1/4"-18          | .97               | 1.76                 | 11/16"   | .34              |
| <b>L272-0806</b> | 1/2"         | 3/8"-18          | .97               | 1.76                 | 11/16"   | .41              |
| <b>L272-0808</b> | 1/2"         | 1/2"-14          | .97               | 1.97                 | 7/8"     | .41              |
| <b>L272-0812</b> | 1/2"         | 3/4"-14          | .97               | 1.97                 | 1 1/16"  | .41              |
| <b>L272-1008</b> | 5/8"         | 1/2"-14          | 1.45              | 2.45                 | 7/8"     | .53              |
| <b>L272-1012</b> | 5/8"         | 3/4"-14          | 1.45              | 2.45                 | 1 1/16"  | .53              |
| <b>L272-1208</b> | 3/4"         | 1/2"-14          | 1.45              | 2.45                 | 7/8"     | .56              |
| <b>L272-1212</b> | 3/4"         | 3/4"-14          | 1.45              | 2.45                 | 1 1/16"  | .66              |

## Push-on, barb to female pipe L274 series

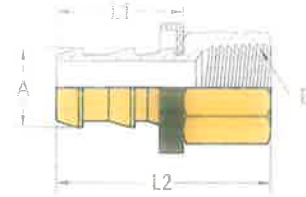

| Part number      | Hose ID<br>A | NPTF thread<br>B | Barb length<br>L1 | Overall length<br>L2 | Hex size | Flow<br>diameter |
|------------------|--------------|------------------|-------------------|----------------------|----------|------------------|
| <b>L274-0402</b> | 1/4"         | 1/8"-27          | .87               | 1.35                 | 1/2"     | .17              |
| <b>L274-0404</b> | 1/4"         | 1/4"-18          | .87               | 1.51                 | 5/8"     | .17              |
| <b>L274-0406</b> | 1/4"         | 3/8"-18          | .87               | 1.53                 | 3/4"     | .17              |
| <b>L274-0502</b> | 5/16"        | 1/8"-27          | .87               | 1.35                 | 1/2"     | .22              |
| <b>L274-0504</b> | 5/16"        | 1/4"-18          | .87               | 1.51                 | 5/8"     | .22              |
| <b>L274-0602</b> | 3/8"         | 1/8"-27          | .97               | 1.45                 | 1/2"     | .22              |
| <b>L274-0604</b> | 3/8"         | 1/4"-18          | .97               | 1.61                 | 5/8"     | .28              |
| <b>L274-0606</b> | 3/8"         | 3/8"-18          | .97               | 1.63                 | 3/4"     | .28              |
| <b>L274-0608</b> | 3/8"         | 1/2"-14          | .97               | 1.77                 | 15/16"   | .28              |
| <b>L274-0804</b> | 1/2"         | 1/4"-18          | .97               | 1.61                 | 5/8"     | .34              |
| <b>L274-0806</b> | 1/2"         | 3/8"-18          | .97               | 1.63                 | 3/4"     | .41              |
| <b>L274-0808</b> | 1/2"         | 1/2"-14          | .97               | 1.77                 | 15/16"   | .41              |
| <b>L274-0812</b> | 1/2"         | 3/4"-14          | .97               | 1.77                 | 1 1/8"   | .41              |
| <b>L274-1008</b> | 5/8"         | 1/2"-14          | 1.45              | 2.25                 | 15/16"   | .53              |
| <b>L274-1012</b> | 5/8"         | 3/4"-14          | 1.45              | 2.25                 | 1 1/8"   | .53              |
| <b>L274-1208</b> | 3/4"         | 1/2"-14          | 1.45              | 2.25                 | 15/16"   | .66              |
| <b>L274-1212</b> | 3/4"         | 3/4"-14          | 1.45              | 2.25                 | 1 1/8"   | .66              |

Push-on

## Push-on, barb to male swivel L285 series

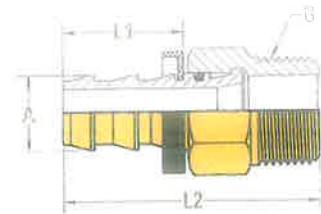

| Part number      | Hose ID<br>A | NPTF thread<br>B | Barb length<br>L1 | Overall length<br>L2 | Hex size | Flow<br>diameter |
|------------------|--------------|------------------|-------------------|----------------------|----------|------------------|
| <b>L285-0404</b> | 1/4"         | 1/4"-18          | .87               | 1.71                 | 9/16"    | .17              |
| <b>L285-0504</b> | 5/16"        | 1/4"-18          | .87               | 1.71                 | 9/16"    | .23              |
| <b>L285-0604</b> | 3/8"         | 1/4"-18          | .97               | 2.00                 | 9/16"    | .28              |
| <b>L285-0606</b> | 3/8"         | 3/8"-18          | .97               | 2.00                 | 11/16"   | .28              |
| <b>L285-0806</b> | 1/2"         | 3/8"-18          | .97               | 2.00                 | 11/16"   | .41              |
| <b>L285-0808</b> | 1/2"         | 1/2"-14          | .97               | 2.00                 | 7/8"     | .41              |

## Push-on, barb to female swivel L286 series

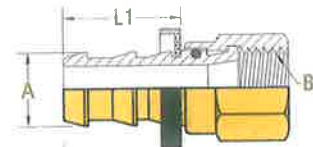

| Part number      | Hose ID<br>A | NPTF thread<br>B | Barb length<br>L1 | Overall length | Hex size | Flow<br>diameter |
|------------------|--------------|------------------|-------------------|----------------|----------|------------------|
| <b>L286-0404</b> | 1/4"         | 1/4"-18          | .87               | 1.71           | 5/8"     | .17              |
| <b>L286-0504</b> | 5/16"        | 1/4"-18          | .87               | 1.71           | 5/8"     | .23              |
| <b>L286-0604</b> | 3/8"         | 1/4"-18          | .97               | 1.81           | 5/8"     | .28              |
| <b>L286-0806</b> | 1/2"         | 3/8"-18          | .97               | 1.85           | 3/4"     | .41              |
| <b>L286-0808</b> | 1/2"         | 1/2"-14          | .97               | 1.85           | 15/16"   | .41              |

## Welding hose, coupling, right hand, oxygen

### L152 series Nut and tailpiece packaged separately

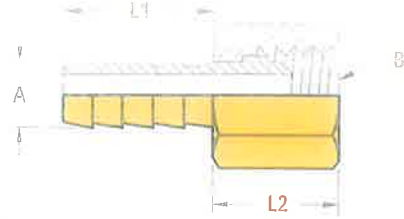

| Part number      | Hose ID<br>A | Nut part number | Right-hand thread<br>B | Barb length<br>L1 | Nut length<br>L2 | Hex size | Flow<br>diameter |
|------------------|--------------|-----------------|------------------------|-------------------|------------------|----------|------------------|
| <b>L15-0309T</b> | 3/16"        | <b>L152-NUT</b> | 9/16"-18               | .97               | .62              | 11/16"   | .12              |
| <b>L15-0409T</b> | 1/4"         | <b>L152-NUT</b> | 9/16"-18               | .97               | .62              | 11/16"   | .17              |
| <b>L15-0509T</b> | 5/16"        | <b>L152-NUT</b> | 9/16"-18               | .97               | .62              | 11/16"   | .22              |
| <b>L15-0609T</b> | 3/8"         | <b>L152-NUT</b> | 9/16"-18               | .97               | .62              | 11/16"   | .28              |

## Welding hose, coupling, left hand, acetylene

### L154 series Nut and tailpiece packaged separately

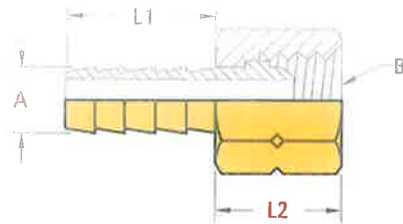

| Part number      | Hose ID<br>A | Nut part number | Left-hand thread<br>B | Barb length<br>L1 | Nut length<br>L2 | Hex size | Flow<br>diameter |
|------------------|--------------|-----------------|-----------------------|-------------------|------------------|----------|------------------|
| <b>L15-0309T</b> | 3/16"        | <b>L154-NUT</b> | 9/16"-18              | .97               | .62              | 11/16"   | .12              |
| <b>L15-0409T</b> | 1/4"         | <b>L154-NUT</b> | 9/16"-18              | .97               | .62              | 11/16"   | .17              |
| <b>L15-0509T</b> | 5/16"        | <b>L154-NUT</b> | 9/16"-18              | .97               | .62              | 11/16"   | .22              |
| <b>L15-0609T</b> | 3/8"         | <b>L154-NUT</b> | 9/16"-18              | .97               | .62              | 11/16"   | .28              |



## Hexagon pipe plug

### L163 series

Reference SAE standard 130109E

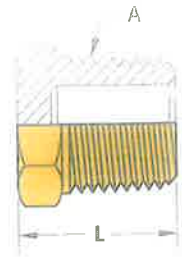

| Part number    | NPTF thread<br>A | Length<br>L | Hex size |
|----------------|------------------|-------------|----------|
| <b>L163-02</b> | 1/8"-27          | .56         | 7/16"    |
| <b>L163-04</b> | 1/4"-18          | .75         | 9/16"    |
| <b>L163-06</b> | 3/8"-18          | .78         | 11/16"   |
| <b>L163-08</b> | 1/2"-14          | .97         | 7/8"     |
| <b>L163-12</b> | 3/4"-14          | 1.06        | 1 1/16"  |

## Hexagon pipe cap

### L313 series

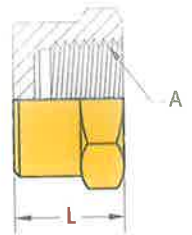

| Part number    | NPTF thread<br>A | Length<br>L | Hex size |
|----------------|------------------|-------------|----------|
| <b>L313-02</b> | 1/8"-27          | .50         | 9/16"    |
| <b>L313-04</b> | 1/4"-18          | .63         | 3/4"     |
| <b>L313-06</b> | 3/8"-18          | .63         | 7/8"     |
| <b>L313-08</b> | 1/2"-14          | .88         | 1 1/16"  |
| <b>L313-12</b> | 3/4"-14          | .94         | 1 3/8"   |

## Hexagon nipple

### L370 series

Reference SAE standard 130137

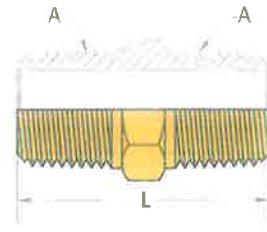

| Part number | NPTF thread<br>A | Length<br>L | Flow<br>diameter |
|-------------|------------------|-------------|------------------|
| L370-0202   | 1/8"-27          | .97         | .22              |
| L370-0404   | 1/4"-18          | 1.38        | .31              |
| L370-0606   | 3/8"-18          | 1.41        | .44              |
| L370-0808   | 1/2"-14          | 1.81        | .56              |
| L370-1212   | 3/4"-14          | 1.81        | .75              |

## Hexagon coupling

### L371 series

Reference SAE standard 130138

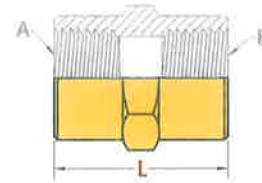

| Part number | NPTF thread<br>A | NPTF thread<br>B | Length<br>L | Hex size | Flow<br>diameter |
|-------------|------------------|------------------|-------------|----------|------------------|
| L371-0202   | 1/8"-27          | 1/8"-27          | .75         | 9/16"    | .33              |
| L371-0404   | 1/4"-18          | 1/4"-18          | 1.12        | 3/4"     | .44              |
| L371-0606   | 3/8"-18          | 3/8"-18          | 1.12        | 7/8"     | .56              |
| L371-0808   | 1/2"-14          | 1/2"-14          | 1.50        | 1 1/16"  | .70              |
| L371-1212   | 3/4"-14          | 3/4"-14          | 1.53        | 1 3/8"   | .90              |

## Hexagon reducing bushing

### L373 series

Reference SAE standard 130140

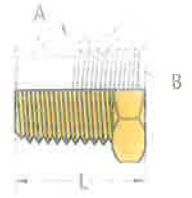

| Part number | NPTF thread<br>A | NPTF thread<br>B | Length<br>L | Hex size | Flow<br>diameter |
|-------------|------------------|------------------|-------------|----------|------------------|
| L373-0402   | 1/4"-18          | 1/8"-27          | .75         | 9/16"    | .33              |
| L373-0602   | 3/8"-18          | 1/8"-27          | .75         | 11/16"   | .33              |
| L373-0604   | 3/8"-18          | 1/4"-18          | .75         | 3/4"     | .44              |
| L373-0802   | 1/2"-14          | 1/8"-27          | 1.00        | 7/8"     | .33              |
| L373-0804   | 1/2"-14          | 1/4"-18          | 1.00        | 7/8"     | .44              |
| L373-0806   | 1/2"-14          | 3/8"-18          | 1.00        | 7/8"     | .56              |
| L373-1202   | 3/4"-14          | 1/8"-27          | 1.00        | 1 1/8"   | .33              |
| L373-1204   | 3/4"-14          | 1/4"-18          | 1.00        | 1 1/8"   | .44              |
| L373-1206   | 3/4"-14          | 3/8"-18          | 1.00        | 1 1/8"   | .56              |
| L373-1208   | 3/4"-14          | 1/2"-14          | 1.00        | 1 1/8"   | .70              |

## Hexagon reducing coupling

### L377 series

Reference SAE standard 130138

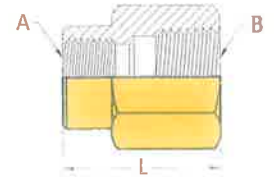

| Part number | NPTF thread<br>A | NPTF thread<br>B | Length<br>L | Hex size | Flow<br>diameter |
|-------------|------------------|------------------|-------------|----------|------------------|
| L377-0402   | 1/4"-18          | 1/8"-27          | .97         | 3/4"     | .33              |
| L377-0602   | 3/8"-18          | 1/8"-27          | .94         | 7/8"     | .33              |
| L377-0604   | 3/8"-18          | 1/4"-18          | 1.16        | 7/8"     | .44              |
| L377-0802   | 1/2"-14          | 1/8"-27          | 1.19        | 1 1/16"  | .33              |
| L377-0804   | 1/2"-14          | 1/4"-18          | 1.28        | 1 1/16"  | .44              |
| L377-0806   | 1/2"-14          | 3/8"-18          | 1.38        | 1 1/16"  | .56              |
| L377-1204   | 3/4"-14          | 1/4"-18          | 1.32        | 1 3/8"   | .44              |
| L377-1206   | 3/4"-14          | 3/8"-18          | 1.32        | 1 3/8"   | .56              |
| L377-1208   | 3/4"-14          | 1/2"-14          | 1.5         | 1 3/8"   | .70              |

## Garden hose, octagon nut OCTA series

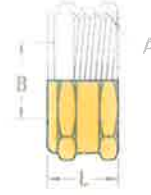

| Part number      | NH thread<br>B | Length<br>L | Hole through<br>B |
|------------------|----------------|-------------|-------------------|
| <b>6050 OCTA</b> | 3/4"-11½       | .55         | .605              |
| <b>7000 OCTA</b> | 3/4"-11½       | .55         | .700              |
| <b>7150 OCTA</b> | 3/4"-11½       | .55         | .715              |
| <b>7800 OCTA</b> | 3/4"-11½       | .55         | .780              |
| <b>8300 OCTA</b> | 3/4"-11½       | .55         | .830              |
| <b>8500 OCTA</b> | 3/4"-11½       | .55         | .850              |
| <b>L19-16</b>    | 1"-11½*        | .72         | 1.062             |

\*NPSH

## Garden hose, end cap

### L513 series

Garden hose washer included

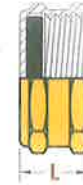

| Part number     | Internal thread | Length<br>L | O. D. size & shape |
|-----------------|-----------------|-------------|--------------------|
| <b>L513-12</b>  | 3/4"-11½ NH     | .55         | 1½" Octagon        |
| <b>L513-12B</b> | 3/4"-11½ NH     | .55         | 1½" Octagon        |
| <b>L513-16</b>  | 1"-11½ NPSH     | .72         | 1½" Octagon        |
| <b>L513-16B</b> | 1"-11½ NPSH     | .72         | 1½" Octagon        |

## Garden hose, male, short barb

### L198 series

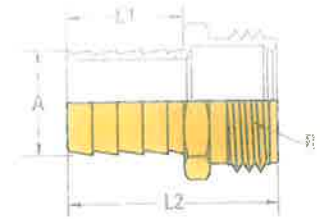

| Part number | Hose ID<br>A | NH thread<br>B | Barb length<br>L1 | Overall length<br>L2 | Octagon size | Flow<br>diameter |
|-------------|--------------|----------------|-------------------|----------------------|--------------|------------------|
| L198-0612   | 3/8"         | 3/4"-11½       | .875              | 1.56                 | 1½"          | .28              |
| L198-0812   | 1/2"         | 3/4"-11½       | .875              | 1.56                 | 1½"          | .37              |
| L198-1012   | 5/8"         | 3/4"-11½       | .875              | 1.56                 | 1½"          | .50              |
| L198-1212   | 3/4"         | 3/4"-11½       | .875              | 1.56                 | 1½"          | .62              |
| L198-1616   | 1"           | 1"-11½*        | 1.125             | 2.00                 | 1½"          | .84              |

\*NPSH

## Garden hose, female swivel, short barb

### L199 series

Garden hose washer included

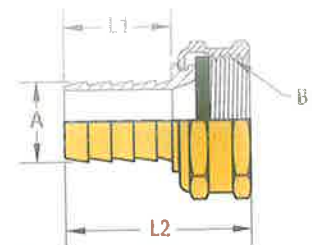

| Part number | Hose ID<br>A | NH thread<br>B | Barb length<br>L1 | Overall length<br>L2 | Octagon size | Flow<br>diameter |
|-------------|--------------|----------------|-------------------|----------------------|--------------|------------------|
| L199-0612   | 3/8"         | 3/4"-11½       | .875              | 1.48                 | 1½"          | .28              |
| L199-0812   | 1/2"         | 3/4"-11½       | .875              | 1.48                 | 1½"          | .40              |
| L199-1012   | 5/8"         | 3/4"-11½       | .875              | 1.48                 | 1½"          | .50              |
| L199-1212   | 3/4"         | 3/4"-11½       | .875              | 1.48                 | 1½"          | .62              |
| L199-1616   | 1"           | 1"-11½*        | 1.125             | 1.90                 | 1½"          | .84              |

\*NPSH

## Garden hose, male

### L190 series

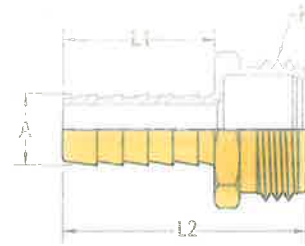

| Part number      | Hose ID<br>A | NH thread<br>B | Barb length<br>L1 | Overall length<br>L2 | Octagon size | Flow<br>diameter |
|------------------|--------------|----------------|-------------------|----------------------|--------------|------------------|
| <b>L190-0612</b> | 3/8"         | 3/4"-11½       | 1.12              | 1.81                 | 1 1/16"      | .28              |
| <b>L190-0812</b> | 1/2"         | 3/4"-11½       | 1.12              | 1.81                 | 1 1/16"      | .37              |
| <b>L190-1012</b> | 5/8"         | 3/4"-11½       | 1.12              | 1.81                 | 1 1/16"      | .50              |
| <b>L190-1212</b> | 3/4"         | 3/4"-11½       | 1.12              | 1.81                 | 1 1/16"      | .62              |
| <b>L190-1612</b> | 1"           | 3/4"-11½       | 1.12              | 1.81                 | 1 1/16"      | .84              |
| <b>L190-1616</b> | 1"           | 1"-11½*        | 1.47              | 2.35                 | 1 1/2"       | .84              |

\*NPSH

## Garden hose, female swivel

### L191 series

Garden hose washer included

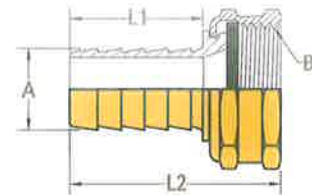

| Part number      | Hose ID<br>A | NH thread<br>B | Barb length<br>L1 | Overall length<br>L2 | Octagon size | Flow<br>diameter |
|------------------|--------------|----------------|-------------------|----------------------|--------------|------------------|
| <b>L191-0612</b> | 3/8"         | 3/4"-11½       | 1.12              | 1.73                 | 1 5/32"      | .28              |
| <b>L191-0812</b> | 1/2"         | 3/4"-11½       | 1.12              | 1.73                 | 1 5/32"      | .41              |
| <b>L191-1012</b> | 5/8"         | 3/4"-11½       | 1.12              | 1.73                 | 1 5/32"      | .50              |
| <b>L191-1212</b> | 3/4"         | 3/4"-11½       | 1.12              | 1.73                 | 1 5/32"      | .62              |
| <b>L191-1612</b> | 1"           | 3/4"-11½       | 1.12              | 1.73                 | 1 5/32"      | .84              |
| <b>L191-1616</b> | 1"           | 1"-11½*        | 1.47              | 2.20                 | 1 1/2"       | .84              |

\*NPSH

## Garden hose, female swivel, long barb

### L195 series

Garden hose washer included

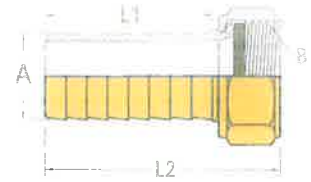

| Part number      | Hose ID<br>A | NH thread<br>B | Barb length<br>L1 | Overall length<br>L2 | Octagon size | Flow<br>diameter |
|------------------|--------------|----------------|-------------------|----------------------|--------------|------------------|
| <b>L195-0812</b> | 1/2"         | 3/4"-11½       | 2.00              | 2.62                 | 1½/32"       | .39              |
| <b>L195-1012</b> | 5/8"         | 3/4"-11½       | 2.00              | 2.62                 | 1½/32"       | .53              |
| <b>L196-1212</b> | 3/4"         | 3/4"-11½       | 2.00              | 2.65                 | 1½/32"       | .63              |
| <b>L195-1616</b> | 1"           | 1"-11½*        | 2.00              | 2.78                 | 1½"          | .84              |

\*NPSH

## Garden hose, male, long barb

### L196 series

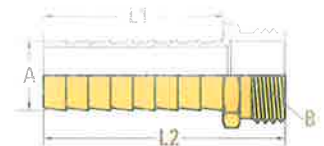

| Part number      | Hose ID<br>A | NH thread<br>B | Barb length<br>L1 | Overall length<br>L2 | Octagon size | Flow<br>diameter |
|------------------|--------------|----------------|-------------------|----------------------|--------------|------------------|
| <b>L196-0812</b> | 1/2"         | 3/4"-11½       | 2.00              | 2.65                 | 1¼/16"       | .39              |
| <b>L196-1012</b> | 5/8"         | 3/4"-11½       | 2.00              | 2.65                 | 1¼/16"       | .53              |
| <b>L196-1212</b> | 3/4"         | 3/4"-11½       | 2.00              | 2.65                 | 1¼/16"       | .63              |
| <b>L196-1616</b> | 1"           | 1"-11½*        | 2.00              | 2.88                 | 1½"          | .84              |

\*NPSH

## Garden hose, spray nozzle, twist-type

### AN series

Garden hose washer included

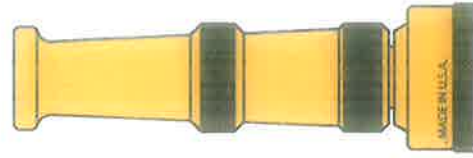

| Part number  | Description                |
|--------------|----------------------------|
| <b>AN-06</b> | 4" Heavy-Duty Hose Nozzle  |
| <b>AN-12</b> | 3" Lightweight Hose Nozzle |
| <b>AN-18</b> | 7" Extreme-Use Hose Nozzle |

## Garden hose, spray nozzle, sweeper

### SN series

Garden hose washer included

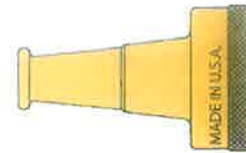

| Part number  | Description                   |
|--------------|-------------------------------|
| <b>SN-22</b> | 2" Solid Brass Sweeper Nozzle |
| <b>SN-44</b> | 4" Solid Brass Sweeper Nozzle |
| <b>SN-66</b> | 6" Solid Brass Sweeper Nozzle |

## Garden hose, washer

### HW series

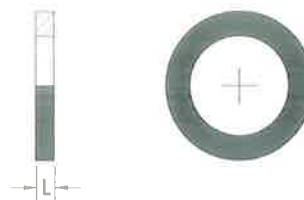

| Part number  | Description | Material     | Length<br>L |
|--------------|-------------|--------------|-------------|
| <b>HW-1</b>  | 3/4" NH     | Molded vinyl | .13         |
| <b>HW-16</b> | 1" NPSH     | Cut rubber   | .13         |



## Garden hose, quick connect coupler QC series



| Part number   | Description                 |
|---------------|-----------------------------|
| <b>QC-10</b>  | Quick-Connect Set (1M & 1F) |
| <b>QC-10F</b> | Female connector only       |
| <b>QC-10M</b> | Male insert only            |
| <b>QD-4</b>   | Replacement washer (vinyl)  |

## Garden hose, quick-connect coupler with shut-off WS series

Garden hose washer included



| Part number   | Description                 |
|---------------|-----------------------------|
| <b>QC-10M</b> | Male insert only            |
| <b>WS-10</b>  | Quick-Connect Set (1M & 1F) |
| <b>WS-10F</b> | Female connector only       |

## Adapter, male hose to female pipe

### MF series

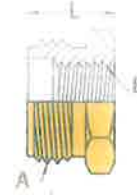

| Part number | NH thread<br>A | NPTF thread<br>B | Length<br>L | Hex size | Flow<br>diameter |
|-------------|----------------|------------------|-------------|----------|------------------|
| MF65-1204   | 3/4"-11½       | 1/4"-18          | .75         | 1 1/16"  | .44              |
| MF65-1206   | 3/4"-11½       | 3/8"-18          | .75         | 1 1/16"  | .56              |
| MF65-1208   | 3/4"-11½       | 1/2"-14          | .75         | 1 1/16"  | .70              |

## Adapter, male hose to female pipe

### MF series

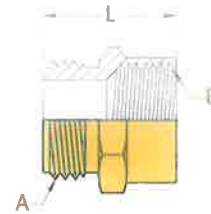

| Part number | Male NH thread<br>A | Female NPTF thread<br>B | Length<br>L | Hex size | Flow<br>diameter |
|-------------|---------------------|-------------------------|-------------|----------|------------------|
| MF67-1212   | 3/4"-11½            | 3/4"-14                 | 1.20        | 1 1/8"   | .75              |
| MF68-1216   | 3/4"-11½            | 1"-11½                  | 1.38        | 1 3/8"   | .75              |
| MF68-1616   | 1"-11½*             | 1"-11½                  | 1.63        | 1 3/8"   | 1.00             |

\*NPSH

## Adapter, male hose to female hose

### MF series

Garden hose washer included

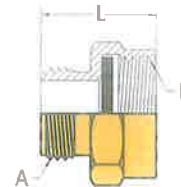

| Part number | Male NH thread<br>A | Female NPSH thread<br>B | Length<br>L | Octagon size | Flow<br>diameter |
|-------------|---------------------|-------------------------|-------------|--------------|------------------|
| MF69-1216   | 3/4"-11½            | 1"-11½                  | 1.31        | 1 1/2"       | .75              |

## Adapter, male pipe to female hose

### MF series

Garden hose washer included

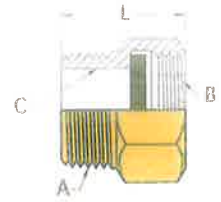

| Part number         | Male NPTF thread<br>A | Female NH thread<br>B | Female NPTF thread<br>C | Length<br>L | Hex size | Flow<br>diameter |
|---------------------|-----------------------|-----------------------|-------------------------|-------------|----------|------------------|
| <b>MF76-0812</b>    | 1/2"-14               | 3/4"-11½              | None                    | 1.125       | 1⅛"      | .56              |
| <b>MF76-0812-06</b> | 1/2"-14               | 3/4"-11½              | 3/8"-18                 | 1.125       | 1⅛"      | .56              |
| <b>MF76-1212</b>    | 3/4"-14               | 3/4"-11½              | None                    | 1.125       | 1⅛"      | .71              |
| <b>MF76-1212-08</b> | 3/4"-14               | 3/4"-11½              | 1/2"-14                 | 1.125       | 1⅛"      | .71              |

## Adapter, male hose to male pipe

### MM series

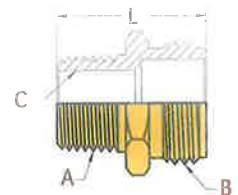

| Part number      | NPTF thread<br>A | NH thread<br>B | NPTF thread<br>C | Length<br>L | Hex size | Flow<br>diameter |
|------------------|------------------|----------------|------------------|-------------|----------|------------------|
| <b>MM65-1208</b> | 3/4"-11½         | 1/2"-14        | None             | 1.30        | 1⅛"      | .56              |
| <b>MM67-1212</b> | 3/4"-11½         | 3/4"-14        | 1/2"-14          | 1.30        | 1⅛"      | .72              |
| <b>MM68-1216</b> | 3/4"-11½         | 1"-11½*        | None             | 1.75        | 1⅜"      | .75              |
| <b>MM68-1616</b> | 1"-11½           | 1"-11½*        | None             | 1.88        | 1⅜"      | 1.00             |

\*NPSH

## Adapter, male hose to male hose

### MM series

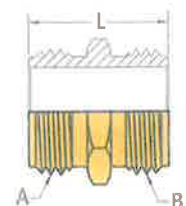

| Part number      | NH thread<br>A | NH thread<br>B | Length<br>L | Hex size | Flow<br>diameter |
|------------------|----------------|----------------|-------------|----------|------------------|
| <b>MM66-1212</b> | 3/4"-11½       | 3/4"-11½       | 1.20        | 1⅛"      | .75              |

## Adapter, female hose to female pipe

### FF series

Garden hose washer included

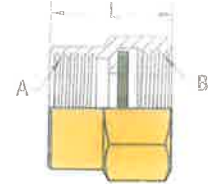

| Part number      | Female NPTF thread<br>A | Female NH thread<br>B | Length<br>L | Hex size | Flow<br>diameter |
|------------------|-------------------------|-----------------------|-------------|----------|------------------|
| <b>FF65-1208</b> | 1/2"-14                 | 3/4"-11½              | 1.125       | 1⅛"      | .70              |
| <b>FF67-1212</b> | 3/4"-14                 | 3/4"-11½              | 1.125       | 1⅛"      | .75              |

## Adapter, female hose to female hose

### FF series

Garden hose washers included

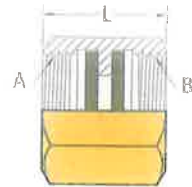

| Part number      | Female NH thread<br>A | Female NH thread<br>B | Length<br>L | Hex size | Flow<br>diameter |
|------------------|-----------------------|-----------------------|-------------|----------|------------------|
| <b>FF66-1212</b> | 3/4"-11½              | 3/4"-11½              | 1.125       | 1⅛"      | .62              |

## Adapter, female pipe to female hose, swivel

### FS series

Garden hose washer included

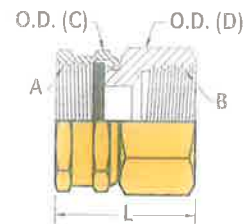

| Part number      | NH thread<br>A | NPTF thread<br>B | Length<br>L | O.D. shape<br>C | O.D. shape<br>D | O.D. size<br>C | O.D. size<br>D | Flow<br>diameter |
|------------------|----------------|------------------|-------------|-----------------|-----------------|----------------|----------------|------------------|
| <b>FS65-1208</b> | 3/4"-11½       | 1/2"-14          | 1.100       | Octagon         | Hex             | 1⅝"            | 15/16"         | .62              |
| <b>FS67-1212</b> | 3/4"-11½       | 3/4"-14          | 1.200       | Octagon         | Hex             | 1⅝"            | 1⅛"            | .62              |
| <b>FS68-1616</b> | 1"-11½*        | 1"-11½           | 1.650       | Octagon         | Hex             | 1½"            | 1⅜"            | .85              |

\*NPSH

## Adapter, female hose to female hose, swivel

### FS series

Garden hose washers included

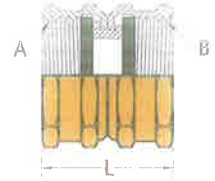

| Part number      | NH thread<br>A | NH thread<br>B | Length<br>L | O.D. shape | O.D. size | Flow<br>diameter |
|------------------|----------------|----------------|-------------|------------|-----------|------------------|
| <b>FS66-1212</b> | 3/4"-11½       | 3/4"-11½       | 1.100       | Octagon    | 1½"       | .56              |
| <b>FS69-1616</b> | 1"-11½*        | 1"-11½*        | 1.440       | Octagon    | 1½"       | .85              |

\*NPSH

## Adapter, male pipe to female hose, swivel, one-piece

### LMFS series

Garden hose washer included

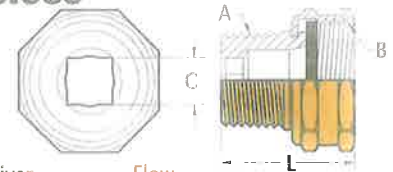

| Part number      | NPTF thread<br>A | NH thread<br>B | Length<br>L | Square driver<br>C | Flow<br>diameter |
|------------------|------------------|----------------|-------------|--------------------|------------------|
| <b>LMFS-0812</b> | 1/2"-14          | 3/4"-11½       | 1⅝          | 3/8"               | .39              |
| <b>LMFS-1212</b> | 3/4"-14          | 3/4"-11½       | 1⅝          | 1/2"               | .53              |
| <b>LMFS-1616</b> | 1"-11½           | 1"-11½*        | 2⅝          | None (1⅜" hex)     | .85              |

\*NPSH

## Adapter, male pipe hose spud

### LMFS-08

Use with garden hose octagon nut 8500 OCTA on page 19

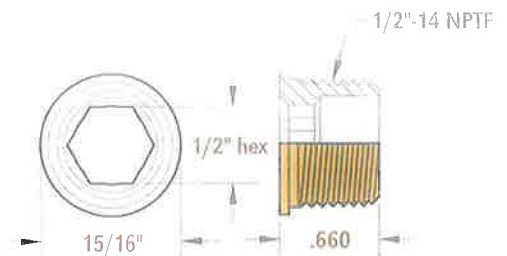

8

FITTING REASONS FOR  
**Octight™**

**EASIER HOSE INSERTION**

(Easy in, not so easy out)

**13% MORE CONTACT**

(Any more would be considered stalking)

**5 SEALS VS. TRADITIONAL 3**

(Now that holds water *and* air)

**PULL-OFF PERFORMANCE  
IMPROVED BY 25%**

(Tested by major OEMs)

**AVAILABLE IN MALE  
AND FEMALE**

(So compatible)

**LESS BRASS REQUIRED**

(Less-is-more fitting)

**HAND-TIGHTEN GARDEN  
HOSES, NO LEAKS**

(Even grandma can do it)

**TIGHTEN AIR FITTINGS  
IN TIGHT PLACES**

(Easier to get a wrench on it)



# Need more than a standard fitting? That's easy, we're **Accomōvative™**

## 8 easy steps to a custom fitting

- 1) Customer provides input and objectives
- 2) Lakeshore modifies standard fitting design (or designs new fitting)
- 3) Customer provides feedback on concept presented by Lakeshore
- 4) Lakeshore makes prototype
- 5) Lakeshore conducts extensive testing
- 6) Lakeshore makes adjustments to prototype
- 7) Lakeshore retests prototype
- 8) Customer provides final design sign-off

### Fitting **before** customization

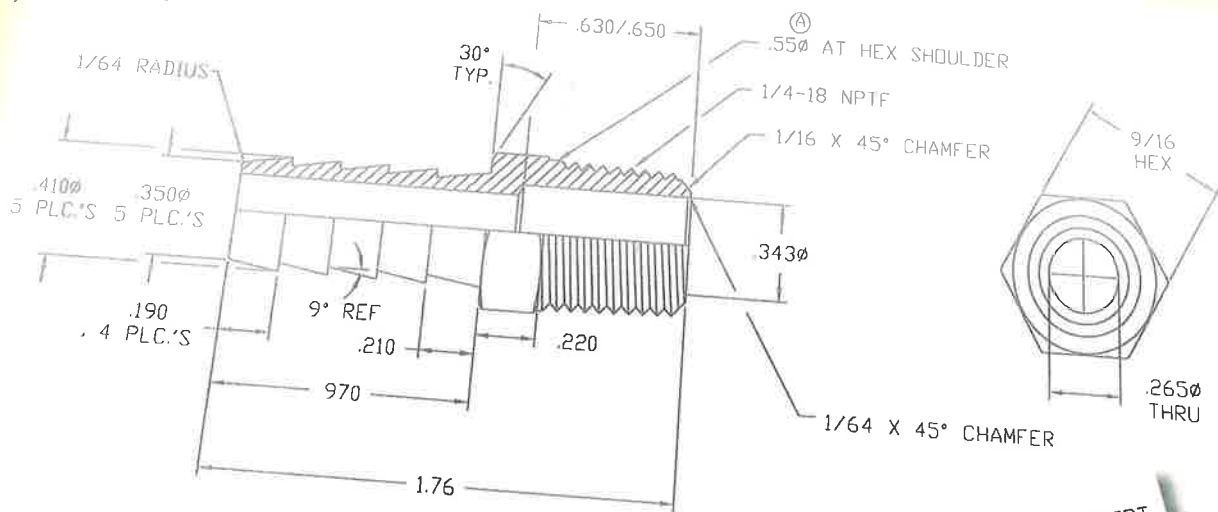

### Fitting **after** customization

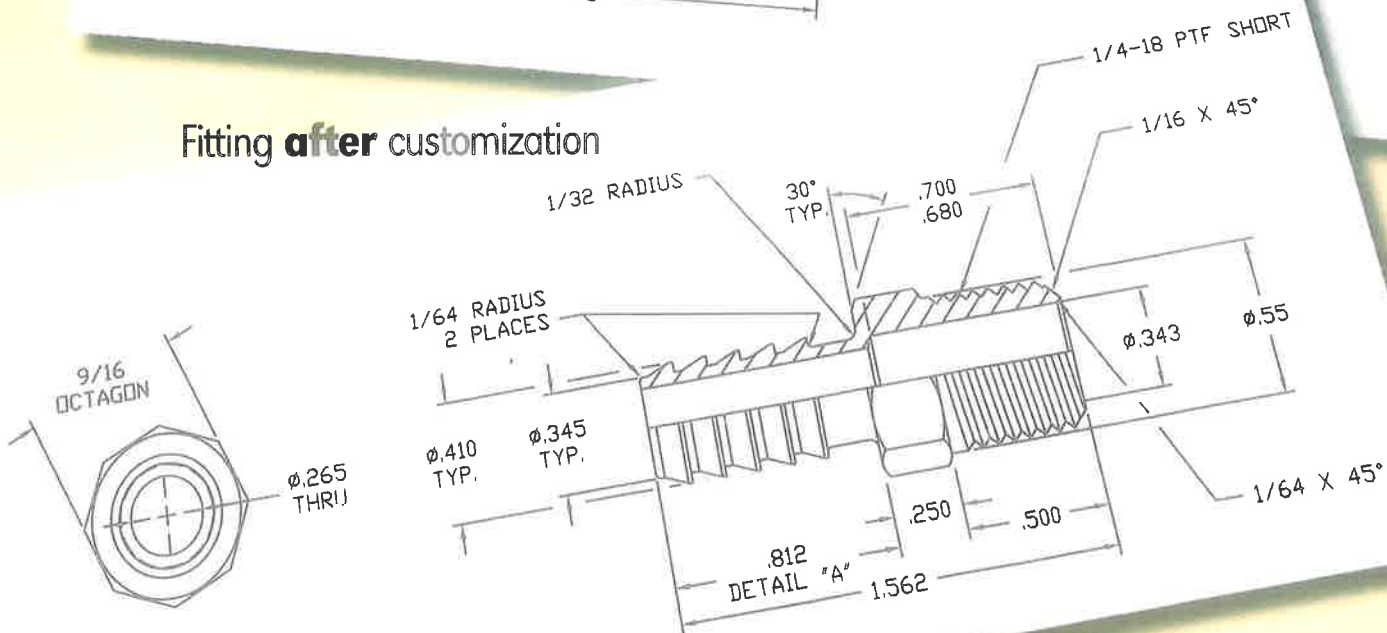

### Results

- Reduced material costs
- Improved performance
- NPTF thread to PTF short dryseal
- Improved hose pull-off

# Lead-free fittings required? No problem, we're **Accomōvative**™

## Advantages

- Lead-free
- Good machinability
- Excellent dezincification corrosion resistance
- Excellent stress corrosion cracking resistance
- High strength equivalent to stainless steel
- Excellent polishing and plating capabilities
- Solders and brazes with standard materials
- Excellent hot forgeability
- Antimicrobial properties

## Applications

- Drinking water fixtures and fittings
- PEX plumbing systems
- Fire protection devices
- Automotive parts: lead-free requirements
- European electrical/electronic parts
- Substitute for free-machining stainless steel
- Medical industry

